

## 1.0SMB Series

### Description

The 1.0SMB series is designed specifically to protect sensitive electronic equipment from voltage transients induced by lightning and other transient voltage events. They have excellent clamping capability, high surge capability, low zener impedance and fast response time. The 1.0SMB series is supplied in YINT Semiconductor's exclusive, cost-effective, highly reliable and is ideally suited for use in communication systems, automotive, numerical controls, process controls, medical equipment, business machines, power supplies and many other industrial/consumer Applications.

### Features

- Case: DO-214AA(SMB)
- Excellent clamping capability
- 1000 W peak pulse power capability with a 10/1000  $\mu$ s waveform
- Typical failure mode is a short circuit condition for current events exceeding component rating
- Fast response time: typically less than 1.0ps from 0 Volts to VB min.
- IEC61000-4-2 (ESD)  $\pm$ 30kV (air),  $\pm$ 30kV (contact).

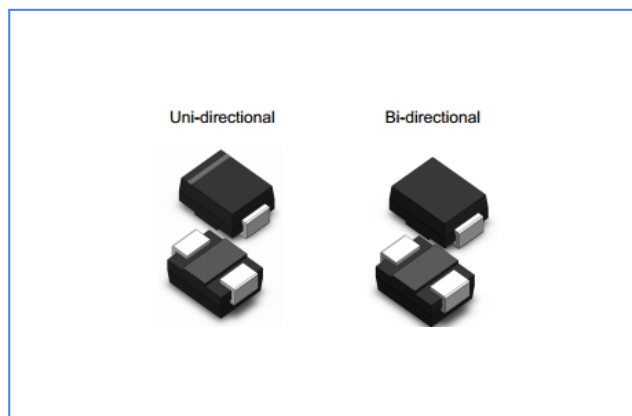

### Functional Diagram

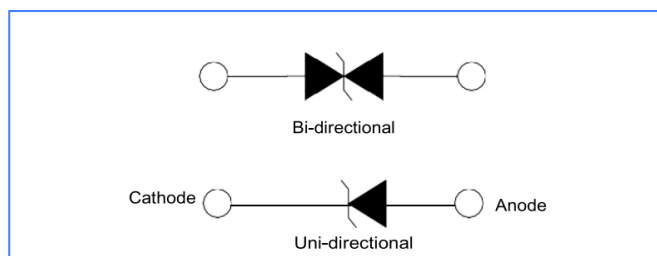

### Applications

TVS devices are ideal for the transient voltage clamp protection of I/O Interfaces, DC power line bus and other circuits used in Telecom, Computer, Industrial and Consumer electronic applications.

### Maximum Ratings ( $T_A=25^\circ\text{C}$ unless otherwise noted)

Parameter	Symbol	Value	Unit
Peak Pulse Power Dissipation at $T_A=25^\circ\text{C}$ by 10/1000 $\mu$ s Waveform	$P_{PK}$	1000	W
Power Dissipation on Infinite Heat Sink at $T_L=50^\circ\text{C}$	$P_D$	5	W
Peak Forward Surge Current, 8.3ms Single Half Sine Wave <sup>1</sup>	$I_{FSM}$	100	A
Maximum Instantaneous Forward Voltage at 50A for Unidirectional Only <sup>2</sup>	$V_F$	3.5	V
Operating Temperature Range	$T_J$	-55 to +150	$^\circ\text{C}$
Storage Temperature Range	$T_{STG}$	-55 to +150	$^\circ\text{C}$

#### NOTES:

1. Measured on 8.3ms single half sine wave or equivalent square wave for unidirectional device only, duty cycle=4 per minute maximum.

**Electrical characteristics (TA = 25 °C unless otherwise noted)**

Part Number (Bi)	Part Number (Uni)	MARKING		Reverse Stand off Voltage V <sub>R</sub> (Volts)	Breakdown Voltage V <sub>BR</sub> (Volts)@I <sub>T</sub>		Test Current I <sub>T</sub> (mA)	Maximum Reverse Leakage I <sub>R</sub> @ V <sub>R</sub> (μA)	Maximum Peak Pulse Current I <sub>pp</sub> (A)	Maximum Clamping Voltage V <sub>C</sub> @I <sub>pp</sub> (V)
		BI	UNI		Min .V	Max .V				
1.0SMB6.8CA	1.0SMB6.8A	N10A	A10A	5.8	6.46	7.14	10	900	95.2	10.5
1.0SMB7.5CA	1.0SMB7.5A	N10B	A10B	6.4	7.13	7.88	10	400	88.5	11.3
1.0SMB8.2CA	1.0SMB8.2A	N10C	A10C	7.0	7.79	8.61	10	180	82.6	12.1
1.0SMB9.1CA	1.0SMB9.1A	N10D	A10D	7.8	8.65	9.56	1	45	74.6	13.4
1.0SMB10CA	1.0SMB10A	N10E	A10E	8.6	9.50	10.50	1	8	69.0	14.5
1.0SMB11CA	1.0SMB11A	N10F	A10F	9.4	10.45	11.55	1	4	64.1	15.6
1.0SMB12CA	1.0SMB12A	N10G	A10G	10.2	11.40	12.60	1	1	59.9	16.7
1.0SMB13CA	1.0SMB13A	N10H	A10H	11.1	12.35	13.65	1	1	54.9	18.2
1.0SMB15CA	1.0SMB15A	N10I	A10I	12.8	14.25	15.75	1	1	47.2	21.2
1.0SMB16CA	1.0SMB16A	N10J	A10J	13.6	15.20	16.80	1	1	44.4	22.5
1.0SMB18CA	1.0SMB18A	N10K	A10K	15.3	17.10	18.90	1	1	39.7	25.2
1.0SMB20CA	1.0SMB20A	N10L	A10L	17.1	19.00	21.00	1	1	36.1	27.7
1.0SMB22CA	1.0SMB22A	N10M	A10M	18.8	20.90	23.10	1	1	32.7	30.6
1.0SMB24CA	1.0SMB24A	N10N	A10N	20.5	22.80	25.20	1	1	30.1	33.2
1.0SMB27CA	1.0SMB27A	N10O	A10O	23.1	25.65	28.35	1	1	26.7	37.5
1.0SMB30CA	1.0SMB30A	N10P	A10P	25.6	28.50	31.50	1	1	24.2	41.4
1.0SMB33CA	1.0SMB33A	N10Q	A10Q	28.2	31.35	34.65	1	1	21.9	45.7
1.0SMB36CA	1.0SMB36A	N10R	A10R	30.8	34.20	37.80	1	1	20.0	49.9
1.0SMB39CA	1.0SMB39A	N10S	A10S	33.3	37.05	40.95	1	1	18.6	53.9
1.0SMB43CA	1.0SMB43A	N10T	A10T	36.8	40.85	45.15	1	1	16.9	59.3
1.0SMB47CA	1.0SMB47A	N10U	A10U	40.2	44.65	49.35	1	1	15.4	64.8
1.0SMB51CA	1.0SMB51A	N10V	A10V	43.6	48.45	53.55	1	1	14.3	70.1
1.0SMB56CA	1.0SMB56A	N10W	A10W	47.8	53.20	58.80	1	1	13.0	77.0
1.0SMB62CA	1.0SMB62A	N10X	A10X	53.0	58.90	65.10	1	1	11.8	85.0
1.0SMB68CA	1.0SMB68A	N10Y	A10Y	58.1	64.60	78.75	1	1	10.9	92.0
1.0SMB75CA	1.0SMB75A	N10Z	A10Z	58.1	71.25	78.75	1	1	9.7	103.0
1.0SMB250CA	1.0SMB250A	N250	A250	214.0	237.0	263.0	1	1	3.0	344.0

### I-V Curve characteristics

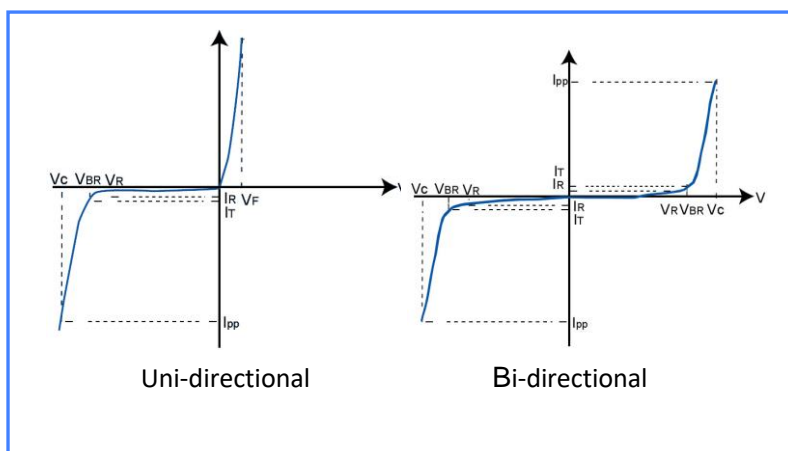

Symbol	Parameter
$I_{PP}$	Maximum Reverse Peak Pulse Current
$V_C$	Clamping Voltage @ $I_{PP}$
$V_{RWM}$	Working Peak Reverse Voltage
$I_R$	Maximum Reverse Leakage Current @ $V_{RWM}$
$V_{BR}$	Breakdown Voltage @ $I_T$ (Test Current)

### Rating & Characteristic Curves

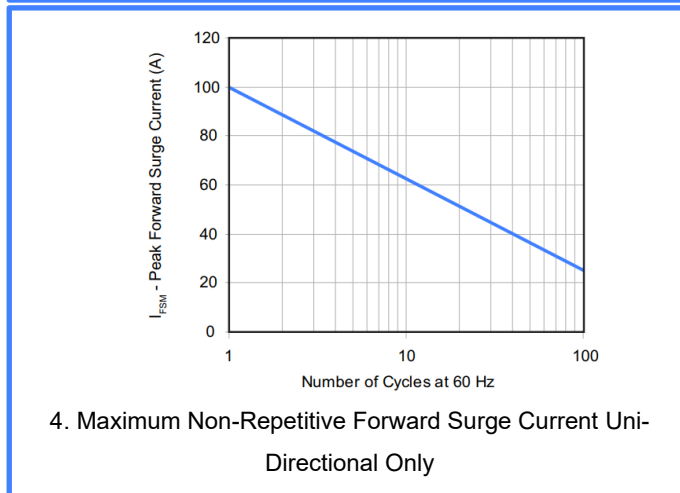
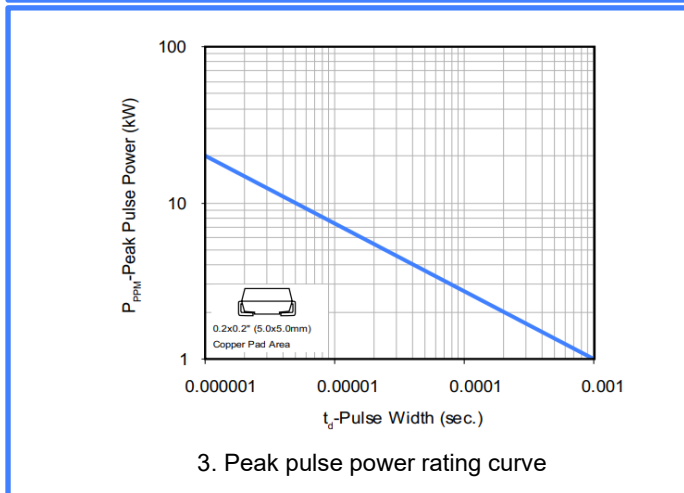
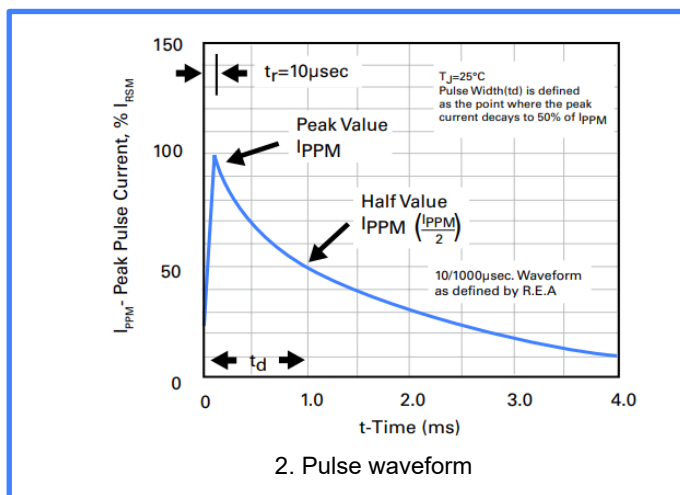
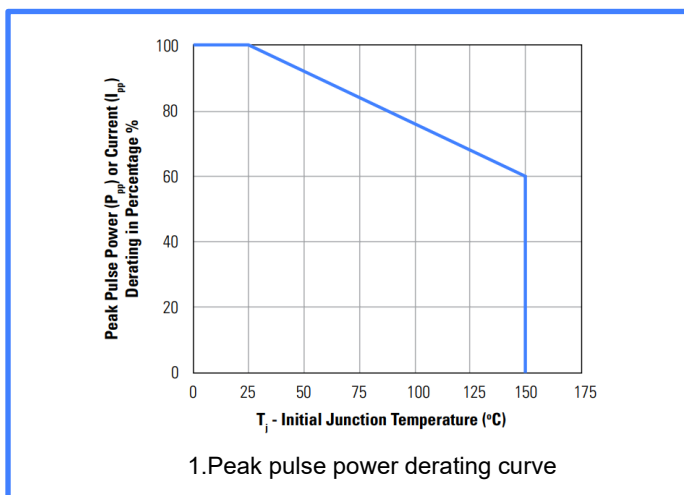

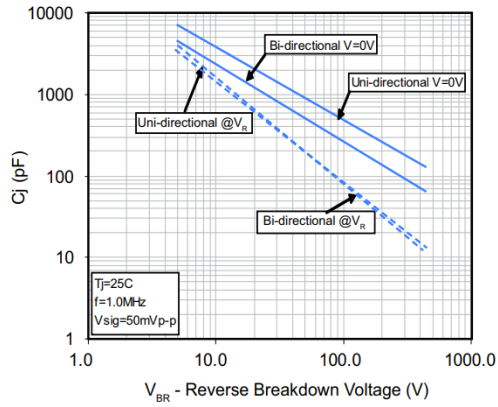

5. Typical Junction Capacitance

### Soldering parameters

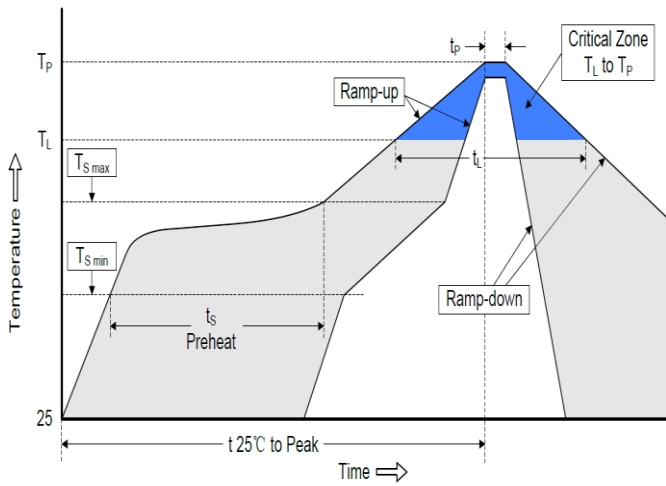

Profile Feature	Pb-Free Assembly
Average ramp-up rate (TL to TP)	3°C/second max.
Preheat	
-Temperature Min (TS min)	150°C
-Temperature Max (TS max)	200°C
-Time (min to max)(ts)	60-180 seconds
TS max to TL	
-Ramp-up Rate	3°C/second max.
Time maintained above:	
- Temperature (TL)	217°C
- Time (tL)	60-150 seconds
Peak Temperature (TP)	260°C
Time within 5°C of actual Peak Temperature (tp)	20-40 seconds
Ramp-down Rate	6°C /second max.
Time 25°C to Peak Temperature	8 minutes max.

**Package outline dimensions in millimeters**

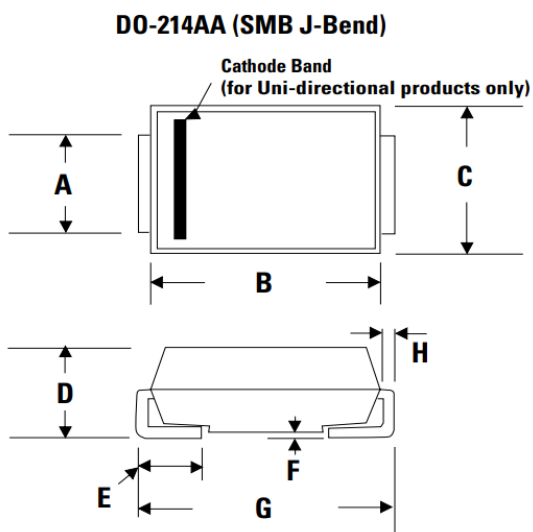

Dimensions	Millimeter	
	Min	Max
A	1.930	2.200
B	4.060	4.750
C	3.300	3.940
D	1.990	2.610
E	0.760	1.520
F	-	0.203
G	5.210	5.590
H	0.152	0.305
I	2.260	-
J	2.160	-
K	-	2.740
L	2.160	-

Mounting Pad Layout

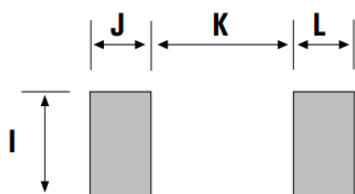

**Part number code & Marking code**

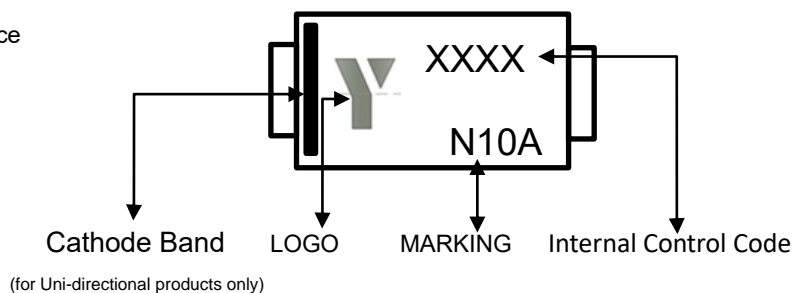
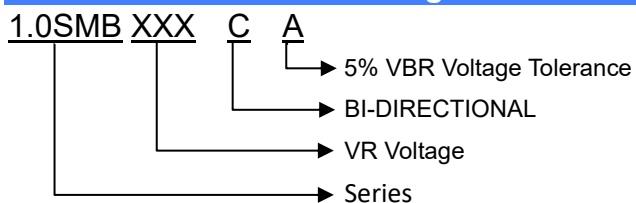

**Disclaimer**

Specifications are subject to change without notice.

The device characteristics and parameters in this data sheet can and do vary in different applications and actual device performance may vary over time.

Users should verify actual device performance in their specific applications.